

Roland® RHYTHM COACH RMP-3 Owner's Manual

Thank you, and congratulations on your choice of the Roland RMP-3.

Before using this unit, carefully read the sections entitled: "USING THE UNIT SAFELY" and "IMPORTANT NOTES" (on another leaflet). These sections provide important information concerning the proper operation of the unit. Additionally, in order to feel assured that you have gained a good grasp of every feature provided by your new unit, Owner's manual should be read in its entirety. The manual should be saved and kept on hand as a convenient reference.

As shipped, the RMP-3's battery is not installed. Please read "Preparations—Loading the Battery" and follow the instructions to install the battery.

Copyright © 2005 ROLAND CORPORATION All rights reserved. No part of this publication may be reproduced in any form without the written permission of ROLAND CORPORATION.

Panel Description

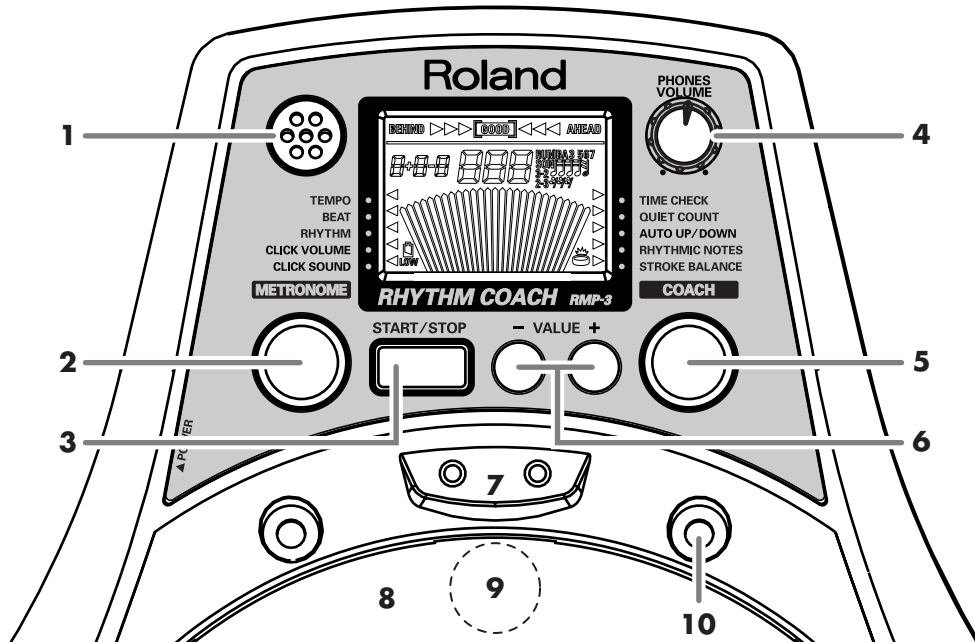

1. Mini Speaker

For the metronome's beep sound only. If the OUTPUT jack is being used, no sound is output.

2. [METRONOME] Button

Selects the metronome parameter.

3. [START/STOP] Button

Starts and stops the metronome.

4. PHONES VOLUME Knob

Adjusts the OUTPUT jack's volume.

* The volume of the mini speaker is adjusted with CLICK VOLUME.

5. [COACH] Button

Selects the Coach mode.

6. VALUE [+]/[-] Button

Use these buttons to change the values of each parameter.

To increase the value rapidly, hold down [+] and press [-]. To decrease the value rapidly, hold down [-] and press [+].

7. BEAT Indicator

Flashes along quarter notes.

Red indicator flashes on accent beats.

8. Head

9. Sensor

10. Tuning Bolts

Adjusts the head tension.

Side Panel

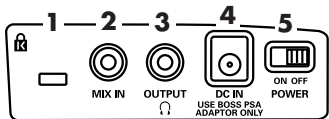

1. Security Slot ()

<http://www.kensington.com/>

2. MIX IN Jack

For connecting an external audio source (CD, MD, etc.) for playing along.

3. OUTPUT Jack

For headphones, amp, or audio system.

* *The RMP-3 outputs sounds in monaural.*

4. AC Adaptor Jack

Connect the AC adaptor (optional) here.

5. POWER Switch

Turns the power on/off.

Preparations

Loading the Battery

1. Press down and slide off the lid of the battery compartment (located on the bottom of the unit).

2. Connect the snap cord to the battery, and place it inside the battery compartment.

* *Verify the battery's polarity (+ versus -).*

3. Securely close the battery cover.

* *Do not let the snap cord get caught in the battery compartment lid.*

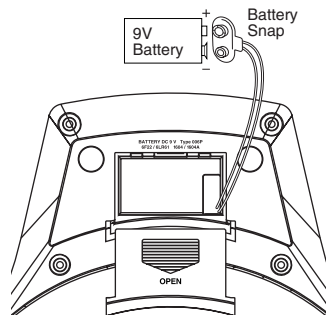

When to Change the Battery

The Battery LOW indicator () at the lower left of the display begins to flash when the battery power drops.

Insufficient battery power lowers the volume level of the mini speaker and causes unstable operation. Replace the battery as soon as possible.

Connecting the AC Adaptor

A BOSS PSA series AC adaptor (sold separately) can be used to power the RMP-3.

NOTE Turn off the power before connecting the AC adaptor.

NOTE Use only the BOSS PSA-series AC adaptor. Other adaptors may cause malfunction or damage to the RMP-3 and must never be used.

MEMO The Battery LOW indicator () flashes when the battery power drops while the AC adaptor is used.

Adjusting the Head Tension

BEFORE playing the RMP-3, you must tune the head to your preferred playing tension. The head is NOT tuned before shipping. Always tighten the tuning bolts in the order shown in the figure.

* *Failure to adjust the tension may result in damage to the head.*

* *Head tension may change with extended use. Make adjustments as needed.*

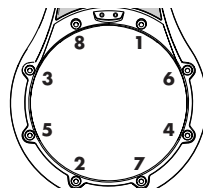

About the Display

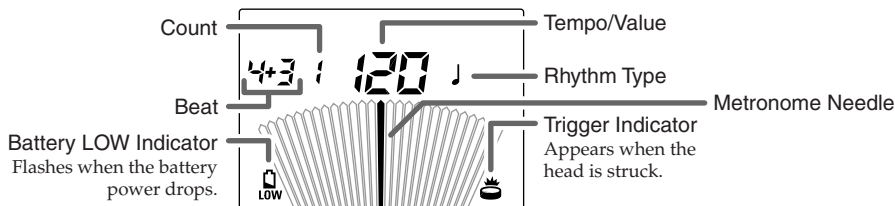

Replacing the Head

If the head has been damaged or no longer maintains correct tension, replace it. To order replacement heads (**RMP-3 Mesh Head**), contact the retailer from whom you purchased the unit or the nearest Roland Service Center.

NOTE The MH-8 Mesh Head is not compatible and cannot be used.

Replacing the Head

When replacing or tuning, use the included tuning key.

1. Remove all tuning bolts.

Gradually loosen each one in order, turning them counterclockwise.

* Do not lose the tuning bolts.

2. Open the case, and then remove the old head.

3. Place the new head in the case.

4. Securely close the case.

5. Attach all eight tuning bolts.

6. Adjust the tension of the head. Refer to "Adjusting the Head Tension."

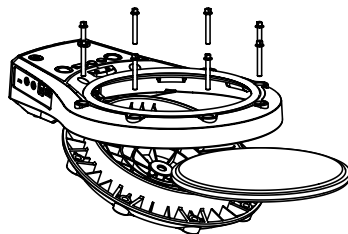

Specifications

Pad Size

8 inches

Tempo

20-260

Beat

24 types

Rhythm Types

18 types

Metronome Sounds

5

Coach Mode

Functions: 5

Exercise Variations: 20

Connectors

PHONES/OUTPUT Jack: 1

(Stereo miniature phone type)

MIX IN Jack: 1 (Miniature phone type)

AC Adaptor Jack

Power Supply

DC 9 V:

Dry Battery 6F22/1604 (9 V) type
(carbon)

Dry Battery 6LR61/1604A (9 V) type

(alkaline)

AC Adaptor

Current Draw

55 mA

* *Expected battery life under continuous use:*

Carbon: 2 hours

Alkaline: 6 hours

These figures will vary depending on the actual conditions of use.

Stand Screw Size

M8

Dimensions

263 (W) x 348 (D) x 78 (H) mm

10-3/8 (W) x 13-3/4 (D) x 3-1/8 (H)

inches

Weight

1.2 kg / 2 lbs 11 oz (including a battery)

Accessories

Dry Battery 6F22/1604 (9 V) type
(carbon)

Tuning Key

Owner's Manual

Leaflet ("USING THE UNIT SAFELY"
and "IMPORTANT NOTES")

Options

AC Adaptor: BOSS PSA series

Pad Stand: PDS-2

* *In the interest of product improvement, the specifications and/or appearance of this unit are subject to change without prior notice.*

Turning the Power On and Off

* Turn on power to your various devices in the order specified. By turning on devices in the wrong order, you risk causing malfunction and/or damage to speakers and other devices.

1. Turn the PHONES VOLUME knob to the minimum level (completely to the left).
2. Turn on the POWER switch.

* This unit is equipped with a protection circuit. A brief interval (a few seconds) after power up is required before the unit will operate normally.

3. While striking the head, gradually turn the PHONES VOLUME knob to adjust the volume level.

When Using with the Amp/Audio System

* To prevent malfunction and/or damage to speakers or other devices, always turn down the volume, and turn off the power on all devices before making any connections.

1. Turn down the volume control on each of the devices in your system.
2. Turn on the power of the RMP-3.
3. Turn on the connected amp or audio system, and adjust the volume to the desired level.



When using with an audio system, the PHONES VOLUME level should not be greater than the middle position (12 o'clock).



When Turning Off the Power

Before switching off the power, lower the volume on each of the devices in your system and then turn off the devices in the reverse order to which they were switched on.

Using the Metronome

1. Press [METRONOME] to display ◀ at the left of the display.
2. Press [METRONOME] a few times to select the desired parameter.

Parameter	Value	Description
TEMPO	20–260	Tempo
BEAT	0–9, 2+3, 3+2, 3+4, 4+3, 4+5, 5+4, 5+6, 6+5, 6+7, 7+6, 7+8, 8+7, 8+9, 9+8	Time signature
RHYTHM	<p>3-2 son clave ($\frac{3}{2}$), 2-3 son clave ($\frac{2}{3}$), 3-2 rumba clave ($\frac{3}{2}$), 2-3 rumba clave ($\frac{2}{3}$)</p>	Rhythm type
CLICK VOLUME	0 (Off)–3 (Max.)	Metronome volume
CLICK SOUND	1 (Higher tone)–5 (Lower tone)	Type of metronome sound

TIP Hold down [METRONOME] and press [-] to have selections come up in the reverse order.

3. Press [+] or [-] to set the values for each parameter.
4. Press [START/STOP] to turn the metronome on and off.

COACH Mode

The RMP-3's Coach mode is a unique set of exercises specifically designed to help build speed, accuracy, stamina, and better timing skills. The Coach modes have programmable parameters, allowing you to adapt the functions to your specific needs.

1. Press [COACH] to display ► at the right of the display.
2. Press [COACH] a few times to select the desired function.

TIME CHECK	Correctly playing in time with the beat
QUIET COUNT	Developing internal timing sense
AUTO UP/DOWN	Tempo increase/decrease exercise
RHYTHMIC NOTES	Learning rhythmic note values
STROKE BALANCE	Checking the striking force (playing dynamics)

TIP Hold down [COACH] and press [-] to have selections come up in the reverse order.

3. Press [+] or [-] to select the exercise variation.
4. Press [START/STOP] to begin/finish the exercise.

TIME CHECK

TIME CHECK is a function designed to develop good timing skills through visual use of the display. As you play along with the metronome, your performance is measured against the timing of the click, and the result is displayed. The chart below explains what the display indicates.

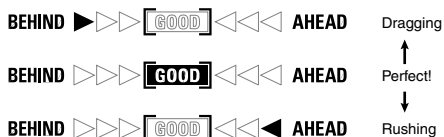

1. Press [COACH] a few times until ► is displayed at "TIME CHECK."
2. Press [+] or [-] to select exercise variation.

E 5 4	Checks performance using relatively easier timing. (initial setting)
H r d	Checks performance using more exact timing.
E - 5	E 5 4 with the point score
H - 5	H r d with the point score
Point Score:	After a two measure count-in, your performance for 8 measures is checked. Then the percentage of correct timing will be displayed.

3. Press [START/STOP] to begin the exercise.
4. When finished, press [START/STOP] again.
 - * Your performance is measured against the quarter note regardless of RHYTHM type of the metronome.
 - * To change the tempo during the exercise, press [+] or [-].

Exercise Example



QUIET COUNT

QUIET COUNT is a function designed to develop your internal tempo “clock.” The click plays at a fixed volume level for a cycle of 1, 2, 3, 4, 6, or 8 measures, and then plays the equal amount or 1 or 2 measures (see below) at a barely audible level. The cycle repeats until you press [START/STOP].

1. Press [COACH] a few times until ► is displayed at “QUIET COUNT.”
2. Press [+] or [-] to select exercise variation.

q-1	1 measure cycle
q-2	2 measure cycle
q-4	4 measure cycle (initial setting)
q-8	8 measure cycle
q3-1	3 (with) plus 1 (quiet) measure cycle
q6-2	6 (with) plus 2 (quiet) measure cycle

3. Press [START/STOP] to begin the exercise.
4. When finished, press [START/STOP] again.

* To change the tempo during the exercise, press [+] or [-].

Exercise Example (Exercise Variation: q-2)

The musical notation shows a metronome pattern of quarter notes followed by rests, and a performance pattern of eighth notes. The rhythm pattern below the performance staff is RLRLRLRL repeated four times.

AUTO UP/DOWN

AUTO UP/DOWN is designed to improve playing stamina by increasing and then decreasing the metronome speed. The metronome’s tempo will increase until it reaches the maximum tempo. (See below.) Then the metronome’s tempo will decrease until it reaches the starting tempo. This will repeat until you press [START/STOP].

1. Press [COACH] a few times until ► is displayed at “AUTO UP/DOWN.”
2. Press [+] or [-] to select exercise variation.

1b	The tempo will increase and/or decrease by 1 BPM on every beat.
2b	The tempo will increase and/or decrease by 1 BPM every two beats. (initial setting)
8-2	The tempo will increase and/or decrease by 2 BPM every eight measures.
8-5	The tempo will increase and/or decrease by 5 BPM every eight measures.
8-r	The tempo will increase and/or decrease every eight measures. The amount by which the tempo changes also increases as the tempo continues to increase. * When the tempo of the metronome is changed, practice begins at the tempo closest to one of starting tempos in the predetermined stepped settings.

3. Press [START/STOP] to begin the exercise.
4. When finished, press [START/STOP] again.

* After starting the click, you can set the desired maximum tempo by pressing [-] when it reaches the desired tempo. To clear the maximum tempo, press [+] (initial value: 260).



This allows you to determine the tempos that are difficult for you.

RHYTHMIC NOTES

RHYTHMIC NOTES is based on a traditional warm up exercise and also helps in learning rhythmic note values. After a two measure count-in, the metronome plays through a series of note intervals or beat divisions. Each one is played for 2 measures before moving on to the next interval level. The exercise starts with half notes, stepping up through intervals to 16th-note triplets, and then back down to half notes again.

1. Press [COACH] a few times until ► is displayed at "RHYTHMIC NOTES."
2. Press [+] or [-] to select exercise variation.

r - 5	Start  (initial setting)
r - 7	Start 
r - 9	Start 

3. Press [START/STOP] to begin the exercise.
 4. When finished, press [START/STOP] again.
- * To change the tempo during the exercise, press [+] or [-].

STROKE BALANCE

This function checks the striking force differences between the right and left hands (or one hand).

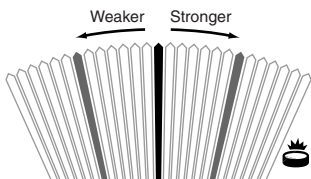

1. Press [COACH] a few times until ► is displayed at "STROKE BALANCE."
2. Press [+] or [-] to select exercise variation.

FL 5	The needle disappears right after striking. (initial setting)
HL 4	The needle remains after striking.

3. Press [START/STOP] to turn the metronome on and off.
- * To change the tempo during the exercise, press [+] or [-].
- * If you strike near the sensor, the needle shows "Stronger."

Exercise Example (Double Stroke Roll)



Advanced Use

TIME CHECK for Off-Beat Eighth Notes

You can check the timing of off-beat eighth notes.





1. Set the metronome's parameters described as below.

BEAT: 0, RHYTHM: γ 

2. Begin the exercise.

While listening to the metronome play down beat in quarter notes, you can check the timing of the off-beat eighth note on the display. (See below.)

Metronome    

Performance γ  γ  γ  γ  

Exercise with Accent



Single Paradiddle



Adjusting the Head Sensitivity

The sensitivity of the head can be adjusted to adapt to your playing dynamics.

1. While simultaneously holding down [METRONOME] and [COACH], turn on the power.

The display shows "5 5 5."

2. Press [+] or [-] to adjust the sensitivity. (initial setting: 6)
Setting this to a higher value makes the sensitivity higher.
3. When finished, press [START/STOP].

The setting is stored, and then the RMP-3 is in the Metronome mode.

Restoring the Factory Settings

This restores the RMP-3 to the original factory settings.

1. Hold down [START/STOP] and turn on the power.

The display shows "r 5 t."

2. Press [START/STOP] again and keep pressing to execute the restoring.



All settings are returned to the default factory settings.

As the Factory Reset progresses, the position of the metronome's needle that is illuminated moves accordingly; when the procedure is finished, the RMP-3 returns to the Metronome mode.







USING THE UNIT SAFELY

INSTRUCTIONS FOR THE PREVENTION OF FIRE, ELECTRIC SHOCK, OR INJURY TO PERSONS

About  WARNING and  CAUTION Notices











 WARNING	Used for instructions intended to alert the user to the risk of death or severe injury should the unit be used improperly.
 CAUTION	Used for instructions intended to alert the user to the risk of injury or material damage should the unit be used improperly. * Material damage refers to damage or other adverse effects caused with respect to the home and all its furnishings, as well to domestic animals or pets.

About the Symbols























	The  symbol alerts the user to important instructions or warnings. The specific meaning of the symbol is determined by the design contained within the triangle. In the case of the symbol at left, it is used for general cautions, warnings, or alerts to danger.
	The  symbol alerts the user to items that must never be carried out (are forbidden). The specific thing that must not be done is indicated by the design contained within the circle. In the case of the symbol at left, it means that the unit must never be disassembled.
	The  symbol alerts the user to things that must be carried out. The specific thing that must be done is indicated by the design contained within the circle. In the case of the symbol at left, it means that the power-cord plug must be unplugged from the outlet.

ALWAYS OBSERVE THE FOLLOWING

WARNING

- Before using this unit, make sure to read the instructions below, and the Owner's Manual. 
- Do not open (or modify in any way) the unit or its AC adaptor. 
- Do not attempt to repair the unit, or replace parts within it (except when this manual provides specific instructions directing you to do so). Refer all servicing to your retailer, the nearest Roland Service Center, or an authorized Roland distributor, as listed on the "Information" page. 
- Never use or store the unit in places that are:
 - Subject to temperature extremes (e.g., direct sunlight in an enclosed vehicle, near a heating duct, on top of heat-generating equipment); or are 
 - Damp (e.g., baths, washrooms, on wet floors); or are 
 - Humid; or are
 - Exposed to rain; or are
 - Dusty; or are
 - Subject to high levels of vibration.
- This unit should be used only with the stand that is recommended by Roland (PDS-2). 
- When using the unit with the stand recommended by Roland (PDS-2), the stand must be carefully placed so it is level and sure to remain stable. If not using a stand, you still need to make sure that any location you choose for placing the unit provides a level surface that will properly support the unit, and keep it from wobbling. 
- Use only the specified AC adaptor (BOSS PSA series), and make sure the line voltage at the installation matches the input voltage specified on the AC adaptor's body. Other AC adaptors may use a different polarity, or be designed for a different voltage, so their use could result in damage, malfunction, or electric shock. 
- Do not excessively twist or bend the power cord, nor place heavy objects on it. Doing so can damage the cord, producing severed elements and short circuits. Damaged cords are fire and shock hazards! 
- This unit, either alone or in combination with an amplifier and headphones or speakers, may be capable of producing sound levels that could cause permanent hearing loss. Do not operate for a long period of time at a high volume level, or at a level that is uncomfortable. If you experience any hearing loss or ringing in the ears, you should immediately stop using the unit, and consult an audiologist. 

WARNING

- Do not allow any objects (e.g., flammable material, coins, pins); or liquids of any kind (water, soft drinks, etc.) to penetrate the unit. 
 - Immediately turn the power off, remove the AC adaptor from the outlet, and request servicing by your retailer, the nearest Roland Service Center, or an authorized Roland distributor, as listed on the "Information" page when:
 - The AC adaptor or the power-supply cord has been damaged; or
 - If smoke or unusual odor occurs
 - Objects have fallen into, or liquid has been spilled onto the unit; or
 - The unit has been exposed to rain (or otherwise has become wet); or
 - The unit does not appear to operate normally or exhibits a marked change in performance.
 - In households with small children, an adult should provide supervision until the child is capable of following all the rules essential for the safe operation of the unit. 
 - Protect the unit from strong impact. (Do not drop it!) 
 - Do not force the unit's power-supply cord to share an outlet with an unreasonable number of other devices. Be especially careful when using extension cords—the total power used by all devices you have connected to the extension cord's outlet must never exceed the power rating (watts/ amperes) for the extension cord. Excessive loads can cause the insulation on the cord to heat up and eventually melt through. 
 - Before using the unit in a foreign country, consult with your retailer, the nearest Roland Service Center, or an authorized Roland distributor, as listed on the "Information" page. 
 - Batteries must never be recharged, heated, taken apart, or thrown into fire or water. 
- The unit and the AC adaptor should be located so their location or position does not interfere with their proper ventilation. 
 - This is for use only with Roland stand PDS-2. Use with other stands is capable of resulting in instability causing possible injury. 
 - Always grasp only the output plug or the body of the AC adaptor when plugging into, or unplugging from, this unit or an outlet. 
 - At regular intervals, you should unplug the AC adaptor and clean it by using a dry cloth to wipe all dust and other accumulations away from its prongs. Also, disconnect the power plug from the power outlet whenever the unit is to remain unused for an extended period of time. Any accumulation of dust between the power plug and the power outlet can result in poor insulation and lead to fire. 
 - Try to prevent cords and cables from becoming entangled. Also, all cords and cables should be placed so they are out of the reach of children. 
 - Never climb on top of, nor place heavy objects on the unit. 
 - Never handle the AC adaptor body, or its output plugs, with wet hands when plugging into, or unplugging from, an outlet or this unit. 
 - Before moving the unit, disconnect the AC adaptor and all cords coming from external devices. 
 - Before cleaning the unit, turn off the power and unplug the AC adaptor from the outlet. 
 - Whenever you suspect the possibility of lightning in your area, disconnect the AC adaptor from the outlet. 
 - If used improperly, batteries may explode or leak and cause damage or injury. In the interest of safety, please read and observe the following precautions. 
 - Carefully follow the installation instructions for batteries, and make sure you observe the correct polarity. 
 - Remove the batteries whenever the unit is to remain unused for an extended period of time. 
 - If a battery has leaked, use a soft piece of cloth or paper towel to wipe all remnants of the discharge from the battery compartment. Then install new batteries. To avoid inflammation of the skin, make sure that none of the battery discharge gets onto your hands or skin. Exercise the utmost caution so that none of the discharge gets near your eyes. Immediately rinse the affected area with running water if any of the discharge has entered the eyes. 
 - Never keep batteries together with metallic objects such as ballpoint pens, necklaces, hairpins, etc. 
 - Used batteries must be disposed of in compliance with whatever regulations for their safe disposal that may be observed in the region in which you live. 
 - When using brushes, be sure to use nylon brushes. Using metal brushes will not only scratch the head, but can also be hazardous, since the tip of the brush may catch in the mesh of the net. 

For the U.K.

IMPORTANT: THE WIRES IN THIS MAINS LEAD ARE COLOURED IN ACCORDANCE WITH THE FOLLOWING CODE.

BLUE: NEUTRAL
BROWN: LIVE

As the colours of the wires in the mains lead of this apparatus may not correspond with the coloured markings identifying the terminals in your plug, proceed as follows:

The wire which is coloured BLUE must be connected to the terminal which is marked with the letter N or coloured BLACK.

The wire which is coloured BROWN must be connected to the terminal which is marked with the letter L or coloured RED.

Under no circumstances must either of the above wires be connected to the earth terminal of a three pin plug.

IMPORTANT NOTES

In addition to the items listed under "USING THE UNIT SAFELY," please read and observe the following:

Power Supply: Use of Batteries

- Do not connect this unit to same electrical outlet that is being used by an electrical appliance that is controlled by an inverter (such as a refrigerator, washing machine, microwave oven, or air conditioner), or that contains a motor. Depending on the way in which the electrical appliance is used, power supply noise may cause this unit to malfunction or may produce audible noise. If it is not practical to use a separate electrical outlet, connect a power supply noise filter between this unit and the electrical outlet.
- The AC adaptor will begin to generate heat after long hours of consecutive use. This is normal, and is not a cause for concern.
- The use of an AC adaptor is recommended as the unit's power consumption is relatively high. Should you prefer to use batteries, please use the alkaline type.
- When installing or replacing batteries, always turn off the power on this unit and disconnect any other devices you may have connected. This way, you can prevent malfunction and/or damage to speakers or other devices.
- A battery is supplied with the unit. The life of this battery may be limited, however, since its primary purpose was to enable testing.
- Before connecting this unit to other devices, turn off the power to all units. This will help prevent malfunctions and/or damage to speakers or other devices.

Placement

- Using the unit near power amplifiers (or other equipment containing large power transformers) may induce hum. To alleviate the problem, change the orientation of this unit; or move it farther away from the source of interference.
- This device may interfere with radio and television reception. Do not use this device in the vicinity of such receivers.
- Noise may be produced if wireless communications devices, such as cell phones, are operated in the vicinity of this unit. Such noise could occur when receiving or initiating a call, or while conversing. Should you experience such problems, you should relocate such wireless devices so they are at a greater distance from this unit, or switch them off.
- Do not expose the unit to direct sunlight, place it near devices that radiate heat, leave it inside an enclosed vehicle, or otherwise subject it to temperature extremes. Excessive heat can deform or discolor the unit.

- When moved from one location to another where the temperature and/or humidity is very different, water droplets (condensation) may form inside the unit. Damage or malfunction may result if you attempt to use the unit in this condition. Therefore, before using the unit, you must allow it to stand for several hours, until the condensation has completely evaporated.

Maintenance

- For everyday cleaning wipe the unit with a soft, dry cloth or one that has been slightly dampened with water. To remove stubborn dirt, use a cloth impregnated with a mild, non-abrasive detergent. Afterwards, be sure to wipe the unit thoroughly with a soft, dry cloth.
- Never use benzine, thinners, alcohol or solvents of any kind, to avoid the possibility of discoloration and/or deformation.

Additional Precautions

- Use a reasonable amount of care when using the unit's buttons, sliders, or other controls; and when using its jacks and connectors. Rough handling can lead to malfunctions.
- Never strike or apply strong pressure to the display.
- When connecting / disconnecting all cables, grasp the connector itself—never pull on the cable. This way you will avoid causing shorts, or damage to the cable's internal elements.
- To avoid disturbing your neighbors, try to keep the unit's volume at reasonable levels. You may prefer to use headphones, so you do not need to be concerned about those around you (especially when it is late at night).
- This instrument is designed to minimize the extraneous sounds produced when it's played. However, since sound vibrations can be transmitted through floors and walls to a greater degree than expected, take care not to allow these sounds to become a nuisance to neighbors, especially when performing at night and when using headphones.
- When you need to transport the unit, package it in the box (including padding) that it came in, if possible. Otherwise, you will need to use equivalent packaging materials.
- Use a cable from Roland to make the connection. If using some other make of connection cable, please note the following precautions.
 - Some connection cables contain resistors. Do not use cables that incorporate resistors for connecting to this unit. The use of such cables can cause the sound level to be extremely low, or impossible to hear. For information on cable specifications, contact the manufacturer of the cable.

Mounting the RMP-3 on the Stand (PDS-2: Sold Separately)

- First, open the tripod so the legs are spaced at least 50 cm (20") apart.

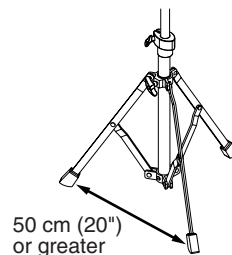

- Attach the wing screw and washer in the order shown in the figure.

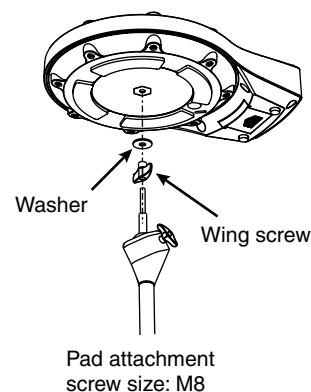

- Attach the pad.

Turn the pad until the screw is just about all the way in; then stop, and tighten the wing screw from underneath the stand.

** Do not forcefully try to turn the pad after the screw is already all the way in. Doing so may damage the stand's screw.*
- Adjust the angle of the pad.

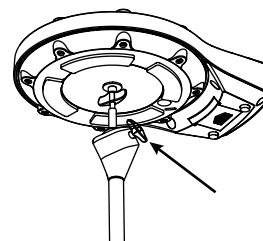

Precautions When Folding the Tripod

When folding the PDS-2's tripod legs to store the unit, take care so as not to get your fingers pinched while handling the stand.



This product complies with the requirements of European Directive 89/336/EEC.

For EU Countries

FEDERAL COMMUNICATIONS COMMISSION RADIO FREQUENCY INTERFERENCE STATEMENT

For the USA

This equipment has been tested and found to comply with the limits for a Class B digital device, pursuant to Part 15 of the FCC Rules. These limits are designed to provide reasonable protection against harmful interference in a residential installation. This equipment generates, uses, and can radiate radio frequency energy and, if not installed and used in accordance with the instructions, may cause harmful interference to radio communications. However, there is no guarantee that interference will not occur in a particular installation. If this equipment does cause harmful interference to radio or television reception, which can be determined by turning the equipment off and on, the user is encouraged to try to correct the interference by one or more of the following measures:

- Reorient or relocate the receiving antenna.
- Increase the separation between the equipment and receiver.
- Connect the equipment into an outlet on a circuit different from that to which the receiver is connected.
- Consult the dealer or an experienced radio/TV technician for help.

This device complies with Part 15 of the FCC Rules. Operation is subject to the following two conditions:
 (1) This device may not cause harmful interference, and
 (2) This device must accept any interference received, including interference that may cause undesired operation.

Unauthorized changes or modification to this system can void the users authority to operate this equipment. This equipment requires shielded interface cables in order to meet FCC class B Limit.

For Canada

NOTICE

This Class B digital apparatus meets all requirements of the Canadian Interference-Causing Equipment Regulations.

AVIS

Cet appareil numérique de la classe B respecte toutes les exigences du Règlement sur le matériel brouilleur du Canada.