

# ANTI-FEEDBACK

# AF-70

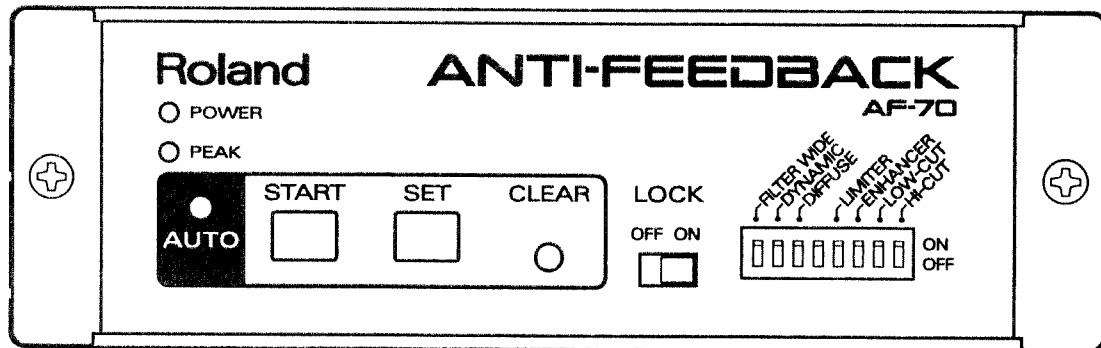

Owner's Manual









# USING THE UNIT SAFELY

## INSTRUCTIONS FOR THE PREVENTION OF FIRE, ELECTRIC SHOCK, OR INJURY TO PERSONS

### About WARNING and CAUTION Notices







 <b>WARNING</b>	Used for instructions intended to alert the user to the risk of death or severe injury should the unit be used improperly.
 <b>CAUTION</b>	Used for instructions intended to alert the user to the risk of injury or material damage should the unit be used improperly. * Material damage refers to damage or other adverse effects caused with respect to the home and all its furnishings, as well to domestic animals or pets.

### About the Symbols





	The  symbol alerts the user to important instructions or warnings. The specific meaning of the symbol is determined by the design contained within the triangle. In the case of the symbol at left, it is used for general cautions, warnings, or alerts to danger.
	The  symbol alerts the user to items that must never be carried out (are forbidden). The specific thing that must not be done is indicated by the design contained within the circle. In the case of the symbol at left, it means that the unit must never be disassembled.
	The  symbol alerts the user to things that must be carried out. The specific thing that must be done is indicated by the design contained within the circle. In the case of the symbol at left, it means that the power-cord plug must be unplugged from the outlet.

### ALWAYS OBSERVE THE FOLLOWING

#### WARNING

- Before using this unit, make sure to read the instructions below, and the Owner's Manual. 
- Do not open (or modify in any way) the unit or its AC adaptor. 
- Do not attempt to repair the unit, or replace parts within it (except when this manual provides specific instructions directing you to do so). Refer all servicing to your dealer, or qualified Roland service personnel. 
- Never use or store the unit in places that are: 
  - Subject to temperature extremes (e.g., direct sunlight in an enclosed vehicle, near a heating duct, on top of heat-generating equipment); or are
  - Damp (e.g., baths, washrooms, on wet floors); or are
  - Humid; or are
  - Dusty; or are
  - Subject to high levels of vibration.
- This unit should be used only with a rack or stand that is recommended by Roland. 
- When using the unit with a rack or stand recommended by Roland, the rack or stand must be carefully placed so it is level and sure to remain stable. If not using a rack or stand, you still need to make sure that any location you choose for placing the unit provides a level surface that will properly support the unit, and keep it from wobbling. 

#### WARNING

- Be sure to use only the AC adaptor supplied with the unit. Also, make sure the line voltage at the installation matches the input voltage specified on the AC adaptor's body. Other AC adaptors may use a different polarity, or be designed for a different voltage, so their use could result in damage, malfunction, or electric shock.  
- Avoid damaging the power cord. Do not bend it excessively, step on it, place heavy objects on it, etc. A damaged cord can easily become a shock or fire hazard. Never use a power cord after it has been damaged. 
- This unit, either alone or in combination with an amplifier and headphones or speakers, may be capable of producing sound levels that could cause permanent hearing loss. Do not operate for a long period of time at a high volume level, or at a level that is uncomfortable. If you experience any hearing loss or ringing in the ears, you should immediately stop using the unit, and consult an audiologist. 
- Do not allow any objects (e.g., flammable material, coins, pins); or liquids of any kind (water, soft drinks, etc.) to penetrate the unit. 

**⚠ WARNING**

- Immediately turn the power off, remove the AC adaptor from the outlet, and request servicing by your dealer or qualified Roland service personnel when:
  - The AC adaptor or the power-supply cord has been damaged; or
  - Objects have fallen into, or liquid has been spilled onto the unit; or
  - The unit has been exposed to rain (or otherwise has become wet); or
  - The unit does not appear to operate normally or exhibits a marked change in performance.
- In households with small children, an adult should provide supervision until the child is capable of following all the rules essential for the safe operation of the unit.
- Protect the unit from strong impact. (Do not drop it!)
- Do not force the unit's power-supply cord to share an outlet with an unreasonable number of other devices. Be especially careful when using extension cords—the total power used by all devices you have connected to the extension cord's outlet must never exceed the power rating (watts/amperes) for the extension cord. Excessive loads can cause the insulation on the cord to heat up and eventually melt through.
- Before using the unit in a foreign country, consult with your dealer, or qualified Roland service personnel.

**⚠ CAUTION**

- The unit and the AC adaptor should be located so their location or position does not interfere with their proper ventilation.
- Always grasp only the plug on the AC adaptor cord when plugging into, or unplugging from, an outlet or this unit.
- Whenever the unit is to remain unused for an extended period of time, disconnect the AC adaptor.
- Try to prevent cords and cables from becoming entangled. Also, all cords and cables should be placed so they are out of the reach of children.
- Never climb on top of, nor place heavy objects on the unit.
- Never handle the AC adaptor or its plugs with wet hands when plugging into, or unplugging from, an outlet or this unit.
- Before moving the unit, disconnect the AC adaptor and all cords coming from external devices.
- Before cleaning the unit, turn off the power and unplug the AC adaptor from the outlet (page 9).
- Whenever you suspect the possibility of lightning in your area, disconnect the AC adaptor from the outlet.

Thank you, and congratulations on your choice of the Roland AF-70 Anti-Feedback unit.

Before using this unit, carefully read the sections entitled: "USING THE UNIT SAFELY" and "IMPORTANT NOTES" (page 2; page 5). These sections provide important information concerning the proper operation of the unit. Additionally, in order to feel assured that you have gained a good grasp of every feature provided by your new unit, this manual should be read in its entirety. The manual should be saved and kept on hand as a convenient reference.

---

---

## Main Features

### Auto Adjust

With the press of a button you can achieve the precise adjustments necessary for eliminating feedback.

The lock feature saves your settings, so you won't lose them even if buttons are pressed accidentally.

### Dynamic Adjust

Instantly cuts sudden, unexpected feedback.

### Diffuse Function

Suppresses the ringing and coloration that occur just before the onset of feedback.

### Built-In Functions Effective for Use with Microphones

- Limiter
- Enhancer
- Low-Cut Filter
- Hi-Cut Filter

You can turn all of these functions on and off with a simple flick of a switch.

### Connects Directly to a Variety of Sound Systems

- Equipped with both XLR-type connectors and a phone jack (TRS)
- Switchable between microphone level and line level input/output
- Balanced input and output (unbalanced input and output also possible)
- Built-in phantom power
- Ground lift function
- Phase switch

### Small, Lightweight, and Easy to Handle

The unit can be rack mounted using a specially designed rack mount adaptor (optional).

---

---

# IMPORTANT NOTES

In addition to the items listed under "USING THE UNIT SAFELY" on page 2, please read and observe the following:

## Power Supply

- Do not use this unit on the same power circuit with any device that will generate line noise (such as an electric motor or variable lighting system).
- The AC adaptor will begin to generate heat after long hours of consecutive use. This is normal, and is not a cause for concern.
- Before connecting this unit to other devices, turn off the power to all units. This will help prevent malfunctions and/or damage to speakers or other devices.

## Placement

- Using the unit near power amplifiers (or other equipment containing large power transformers) may induce hum. To alleviate the problem, change the orientation of this unit; or move it farther away from the source of interference.
- This device may interfere with radio and television reception. Do not use this device in the vicinity of such receivers.
- Do not expose the unit to direct sunlight, place it near devices that radiate heat, leave it inside an enclosed vehicle, or otherwise subject it to temperature extremes. Excessive heat can deform or discolor the unit.

## Maintenance

- For everyday cleaning wipe the unit with a soft, dry cloth or one that has been slightly dampened with water. To remove stubborn dirt, use a cloth impregnated with a mild, non-abrasive detergent. Afterwards, be sure to wipe the unit thoroughly with a soft, dry cloth.
- Never use benzene, thinners, alcohol or solvents of any kind, to avoid the possibility of discoloration and/or deformation.

## Additional Precautions

- Use a reasonable amount of care when using the unit's buttons, sliders, or other controls; and when using its jacks and connectors. Rough handling can lead to malfunctions.
- When connecting / disconnecting all cables, grasp the connector itself—never pull on the cable. This way you will avoid causing shorts, or damage to the cable's internal elements.
- To avoid disturbing your neighbors, try to keep the unit's volume at reasonable levels (especially when it is late at night).
- When you need to transport the unit, package it in the box (including padding) that it came in, if possible. Otherwise, you will need to use equivalent packaging materials.

---

---

# Contents

<b>USING THE UNIT SAFELY</b> .....	<b>2</b>
<b>Main Features</b> .....	<b>4</b>
<b>IMPORTANT NOTES</b> .....	<b>5</b>
<b>About Acoustic Feedback</b> .....	<b>6</b>
What Is Acoustic Feedback?	
To avoid feedback, it is necessary to:	
Using the AF-70	
<b>Panel Descriptions</b> .....	<b>7</b>
<b>Making the Connections</b> .....	<b>9</b>
<b>About Auto Adjust</b> .....	<b>10</b>
How to Use Auto Adjust .....	11
About the Safety Margin .....	12
About Anti-Feedback Filter Bandwidth .....	12
<b>About the Lock Function</b> .....	<b>12</b>
<b>About the Function Setting Switches</b> .....	<b>13</b>
FILTER WIDE	
DYNAMIC	
DIFFUSE	
LIMITER	
ENHANCER	
LOW-CUT/HI-CUT	
<b>Option</b> .....	<b>13</b>
<b>Specifications</b> .....	<b>14</b>

---

---

# About Acoustic Feedback

## What Is Acoustic Feedback?

Acoustic feedback, also known as howling, occurs when the output from the speaker(s) is picked up by a microphone, reamplified, then output again through the speaker, causing an unpleasant oscillating whine. Turning up the microphone volume, pointing the microphone at the speaker, bringing the microphone too close to the speaker, or raising speaker output levels so that the sound enters the microphone may very easily cause feedback.

## To avoid feedback, it is necessary to:

- Set output levels to suit the size of the particular hall or room.
- Locate the microphone as far away from the speakers as possible, and avoid pointing the microphone directly at a speaker.
- Set the levels of connected equipment to appropriate levels.

These measures will help prevent some of the more obviously controllable types of feedback. However, feedback sometimes occurs well below the desired total output level. In such situations, a common technique is to reduce the gain in the vicinity of frequencies where feedback is most likely to occur, and then bring the total mix up to the desired level.

## Using the AF-70

The AF-70's built-in feedback detection function and extremely narrow-band filters work together to automatically detect and eliminate feedback. Used in sound checks, the Auto Adjust function allows fast completion of feedback adjustments. The high-precision design of the feedback detection and anti-feedback filters allows pinpoint accuracy in filtering feedback frequencies, minimizing any deterioration in the quality of the sound.

# Panel Descriptions

## Front Panel

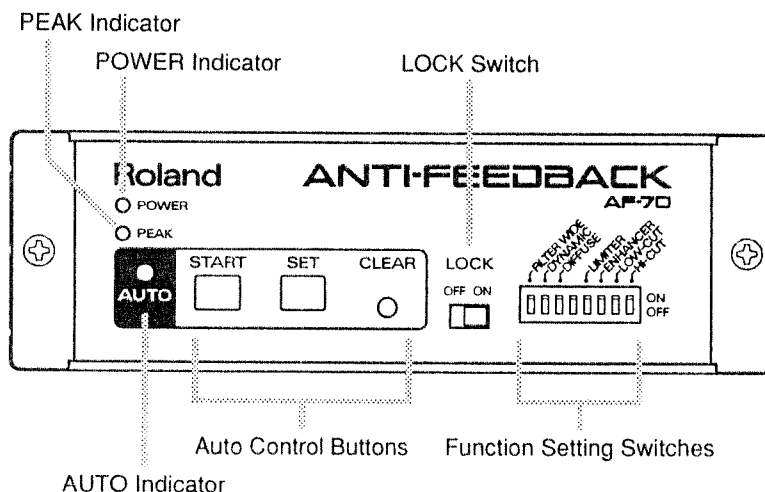

---

### POWER Indicator

With an AC adaptor connected, this indicator lights up when the power is on.

### PEAK Indicator

This indicator lights during high input signal levels. The indicator lights up at 6 dB below the level where distortion begins. If the indicator seems to be lighting up too frequently, flip the input level switch on the rear panel.

### AUTO Indicator

This indicates the operating status of the Auto Adjust function.

**Lit:** Auto Adjust is completed, and the anti-feedback filters are set.

**Flashing:** Auto Adjust is in progress.

**Off:** No anti-feedback filters are set.

### Auto Control Buttons ((START) (SET) (CLEAR))

Pressing the [START] button initiates Auto Adjust.

Pressing the [SET] button ends the Auto Adjust process, and fixes the anti-feedback filter settings.

Holding down the [CLEAR] button for approximately two seconds completely clears the anti-feedback filters.

For more information about Auto Adjust function, please refer to "About Auto Adjust" on page 10.

### LOCK Switch

With the lock function set to "ON," even if the [START], [SET], or [CLEAR] buttons should happen to be pressed, Auto Adjust will not operate (for more on the lock functions see page 12).

### Function Setting Switches

These switches turn on and off each of the following functions: Filter Wide, Dynamic, Diffuse, Limiter, Enhancer, Low-Cut Filter, and Hi-Cut Filter. For more information about each of these functions, please refer to "About the Function Setting Switches" on page 13.

*\* When altering settings, use a ball-point pen or similar object. Do not apply excessive force to the switches, as this may damage the unit.*

*\* The fourth switch from the left is not assigned to any function. Moving this switch has no effect on any operation.*

# Rear Panel

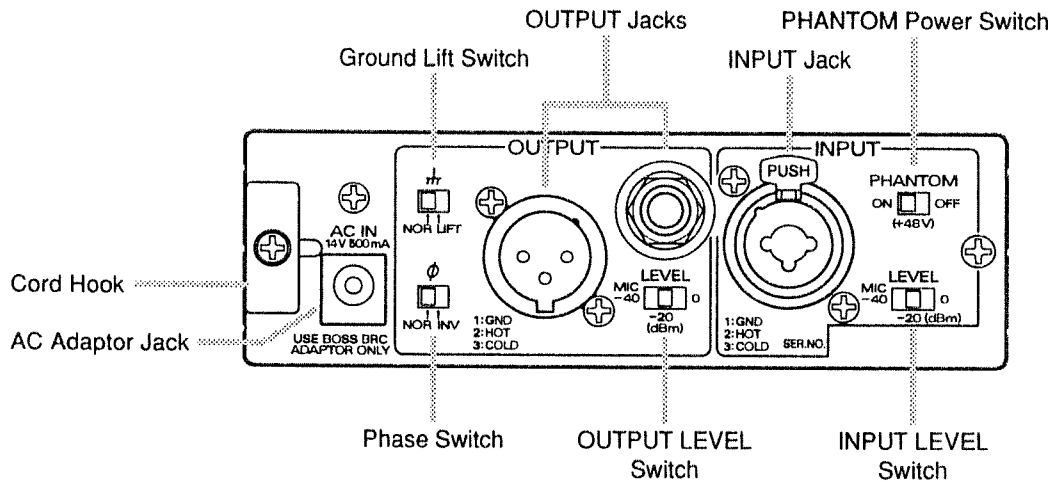

## Cord Hook

To prevent the inadvertent disruption of power to your unit (should the plug be pulled out accidentally), and to avoid applying undue stress to the AC adaptor jack, anchor the power cord using the cord hook, as shown in the illustration.

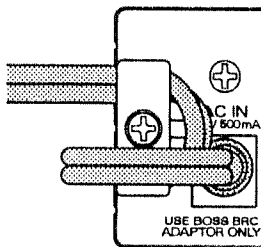

## AC Adaptor Jack

Use the AC adaptor (BRC-Series) included with this unit.

## OUTPUT JACKS

Connect cables from here to the input jacks on your other equipment.

## OUTPUT LEVEL Switch

Use this switch to select the output appropriate for the input level of the equipment being connected. For output to a device expecting microphone-level input, switch to "Mic -40 dBm."

## Phase Switch

Ordinarily, this should be set to "NOR" (normal). Set it to "INV" when you need output that has the phase (polarity) inverted.

## Ground Lift Switch

Should ordinarily be set to "NOR" (normal). If noise arising from a ground loop should occur (while using balanced connections), switch it to "LIFT."

## INPUT JACK

Accepts connection of microphones, or the output from external equipment. Features jack for both XLR-3-31 connectors as well as standard TRS phone plugs.



## INPUT LEVEL Switch

Used to select the level that matches the output level used by the external equipment being connected. If connecting a microphone directly to this unit, switch to "Mic -40 dBm."

## PHANTOM Power Switch

Switch this on when connecting microphones that require phantom power (48 V). Switch it off when connecting other types of microphones, or other devices and equipment.

- \* **Set the phantom power switch to the proper position BEFORE connecting microphones or other devices.**
- \* **You can damage a connected device by having the phantom power switch set to "ON" when the device you have connected actually does not need phantom power. Please check the switch setting before making connections.**

The pin assignments for the input/output jack are shown in the following diagram. Before connecting, check the pin assignments on the device being connected. The phone jack accepts a standard TRS (tip/ring/sleeve) phone plug, and is used for balanced input/output. (Unbalanced input/output is also supported.)

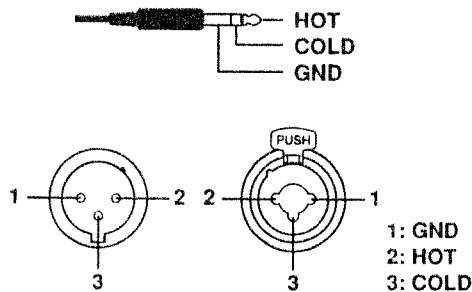

## Making the Connections

As shown in the diagram, connect any peripheral equipment, then plug in the AC adaptor. By connecting the AC adaptor, the power is turned on. The Power indicator lights while power is on.

- \* **Switch the phantom power on or off before making any connections.**
- \* **To prevent malfunction and/or damage to speakers or other devices, always turn down the volume, and turn off the power on all devices before making any connections.**
- \* **Once the connections have been completed, turn on power to your various devices in the order specified. By turning on devices in the wrong order, you risk causing malfunction and/or damage to speakers and other devices.**  
AF-70 → Mixer etc.
- \* **This unit is equipped with a protection circuit. A brief interval (a few seconds) after power up is required before the unit will operate normally.**

### Example 1 Meeting Rooms/Classrooms

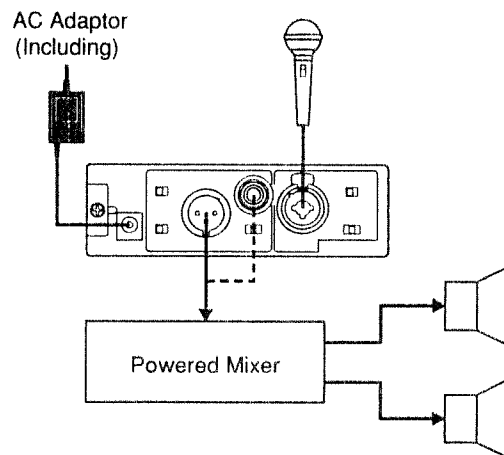

### Example 2 Karaoke/Public Address/Presentations

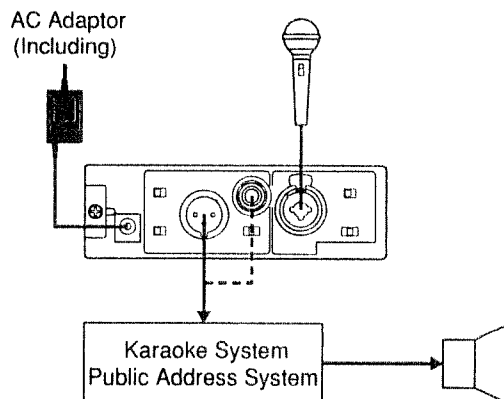

### Example 3 Small-Scale Events/Concerts

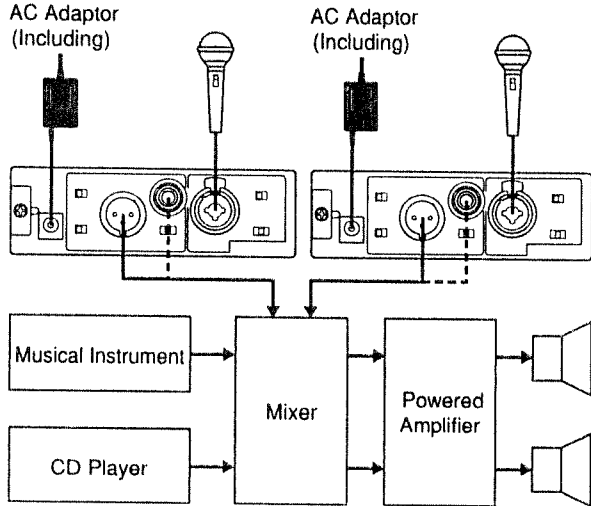

### Example 4 Using a Wireless Microphone

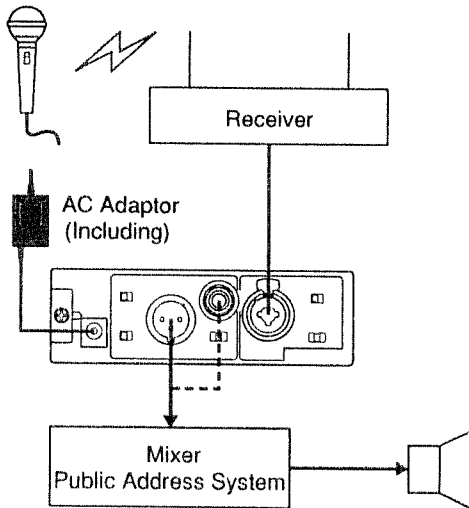

---

---

## About Auto Adjust

The AF-70's Auto Adjust combines three built-in functions (shown below), which provides convenient control over any outbreak of feedback. This allows the realization of stable sound systems featuring fast, automatic prevention of feedback.

### 1. Feedback Detection

Detects feedback, finding the frequencies that are feeding back with extreme precision.

### 2. Anti-Feedback Filter

With twelve extremely narrow-band filters, feedback is suppressed without affecting sound quality.

### 3. Safety Margin Function

This provides a sufficient "safety margin," or gain before feedback, which makes for stable sound systems, even in changing conditions.

## How to Use Auto Adjust

The Auto Adjust function is used during sound checks to make adjustments for eliminating feedback. After all equipment is connected, run the auto adjust procedure during silent conditions (i.e., with no sound entering the microphone).

Before beginning Auto Adjust, set the switches for each function to the settings that will be used in performance. For more information about each function, please see "About the Function Setting Switches" (page 13).

*\* Anti-feedback filter settings made during Auto Adjust are preserved even after the power is turned off. Settings are recalled when the power is turned back on.*

*\* Although feedback may occur momentarily during Auto Adjust, this is due to the feedback detection operation, and settings being made for the safety margin; there is nothing abnormal about this. Feedback ceases after a brief moment.*

*\* Do not talk into the microphone during Auto Adjust.*

1. Turn the microphone switch to "On," set mixer, power amp, and other equipment levels, then bring up the microphone volume until the desired level is reached.

2. Press the [START] button. The Auto indicator flashes, and Auto Adjust begins operation.

Flashing

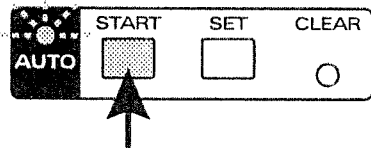

3. Auto Adjust ends automatically after securing a safety margin of approximately 12 dB. The Auto indicator stops flashing and instead will light steadily. The anti-feedback filter settings are fixed. At this point, feedback adjustments made with Auto Adjust are complete.

Lit

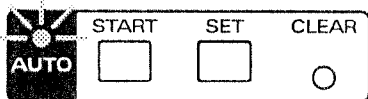

*\* Once all twelve anti-feedback filters are set, Auto Adjust automatically ends (regardless of the safety margin), and the anti-feedback filter settings are fixed (see "About the Safety Margin" on page 12).*

## Stopping Auto Adjust While in Progress

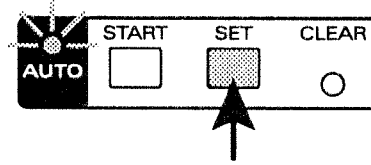

Press the [SET] button. The Auto indicator light goes on, and anti-feedback filter settings made up to that point are set.

## Continuing/Resuming Auto Adjust

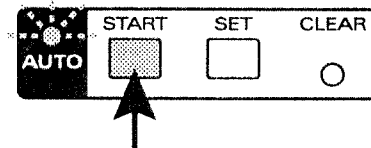

Press the [START] button. Auto Adjust resumes, using settings made up to the point of cancellation.

## Canceling the Anti-Feedback Filter

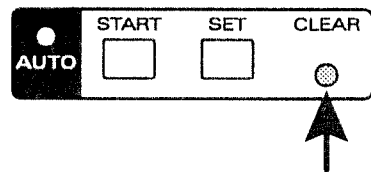

Hold down the [CLEAR] button for approximately two seconds. The Auto Indicator light goes off, and all anti-feedback filters are cleared.

## Restarting Auto Adjust From the Beginning

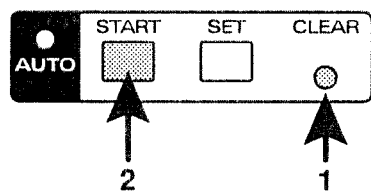

First hold down the [CLEAR] button; this clears filters that have been set. Then press the [START] button to run Auto Adjust.

## About the Safety Margin

At the completion of Auto Adjust, a "safety margin" of approximately 12 dB will have been set up. However, during the Auto Adjust procedure, the Auto indicator will begin to flash rapidly as soon as a safety margin of 6 dB has been achieved. This conveniently allows you to stop Auto Adjust while it is in progress, if you believe that a 6 dB margin is sufficient for your needs.

\* *Auto Adjust ends when all twelve anti-feedback filters are set, even if the approximately 12 dB for the safety margin is not attained. You can check to see whether or not all the anti-feedback filters have been set when the lock function is set to "On" (See "About the Lock Function").*

## About Anti-Feedback Filter Bandwidth

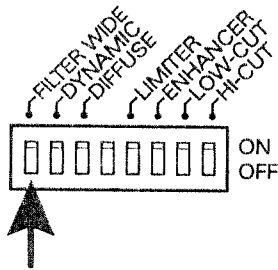

You can modify the bandwidth of the anti-feedback filters by changing the position of the "FILTER WIDE" switch.

### **FILTER WIDE: On**

Filter Bandwidth: 1/10 Octave (Max. 1/6 Octave)  
Characteristic: Greater Elimination of Feedback

### **FILTER WIDE: Off**

Filter Bandwidth: 1/20 Octave (Max. 1/10 Octave)  
Characteristic: Less Extreme Effect on Sound Quality

- \* *Once the anti-feedback filter settings are fixed, changing the Filter Wide switch will not affect the filter bandwidth.*
- \* *When frequencies that are extremely close to each other are feeding back, the filter bandwidth is automatically slightly broadened, and feedback from multiple frequencies is removed with one filter.*
- \* *A bandwidth of 1/20 of an octave corresponds to the definition achieved with a 200-band graphic equalizer.*

## About the Lock Function

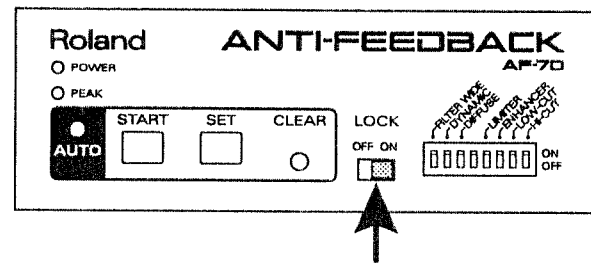

Turning on the Lock function disables the [START], [SET], and [CLEAR] buttons, so even if they are pressed in error, filter settings remain unchanged. When carrying out Auto Adjust, press these settings buttons after turning off the Lock function. After you finish the Auto Adjust procedure, turn the Lock function on once more.

\* *If the Lock function is set during the Auto Adjust procedure, Auto Adjust ends at that point, and the anti-feedback settings are fixed (this also happens if the [SET] button is pressed).*

## Checking the Status of the Filter Settings

With the lock function set to "ON," you can check to see whether all settings for the twelve anti-feedback filters have been made.

After checking to see that the Lock switch is set to "ON," press the [START] and [SET] buttons simultaneously. While they remain pressed simultaneously, the Auto Indicator flashes.

### **Slow flashing:**

Fewer than twelve of the anti-feedback filters are set; approximately 12 dB is secured for the safety margin.

### **Rapid flashing:**

All twelve anti-feedback filters are set. If at this point you wish to ensure a greater safety margin, then readjust the volume levels, and the placement of the microphone and speakers, and repeat Auto Adjust from the beginning.

---

# About the Function Setting Switches

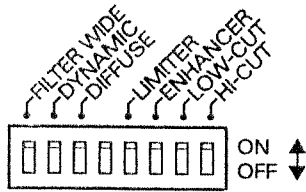

\* Except for *FILTER WIDE*, changing a setting has an immediate effect on the function.

## FILTER WIDE

Switches the bandwidth of the anti-feedback filters when set with Auto Adjust. For a more detailed explanation, see "About Anti-Feedback Filter Bandwidth" (page 12).

## DYNAMIC

This function constantly monitors the reproduced sound, and at the first sign of feedback, it instantly counteracts it, suppressing the feedback. Two anti-feedback filters, assigned for the Dynamic Adjust function, track and eliminate any new occurrence of feedback. These filters have a 1/6-octave bandwidth.

## DIFFUSE

The frequency at which feedback occurs is ordinarily determined by the distance between the microphone and speakers. Given a fixed microphone and speaker placement, and an unchanging volume level, feedback will gradually increase once it occurs. However, by moving the microphone, you can cause the frequency at which feedback is occurring to shift, and suppress the growth of feedback.

The Diffuse function creates such changes in a virtual manner. It is also effective in reducing the unpleasant ringing and coloration that can occur at word endings.

## LIMITER

Limits excessively high input levels, preventing the distortion that results from overload.

## ENHANCER

Enhances voice contour and consonants, and improves the articulation of amplified sound, making speech more intelligible.

\* Note that while you have the *Enhancer* switched on, some distortion may occur, even though the *Peak* indicator has not lighted.

## LOW-CUT/HI-CUT

Cuts both the low-end and high-end frequencies that are unnecessary for listening to ordinary voices. Effective against hiss and bass rumble circulating from floors.

---

## Option

With the optional RAF-70 rack mount adaptor, a row of up to three AF-70s can be mounted in an EIA-1U rack.

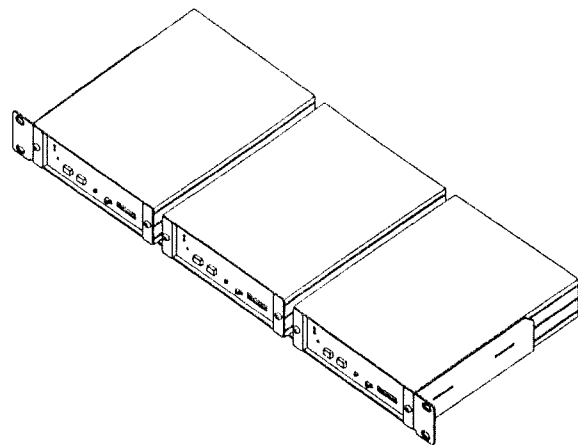

---

---

# Specifications

## AF-70: ANTI-FEEDBACK

### AD Conversion

22 bit AF Method

### DA Conversion

18 bit 16 Times Oversampling  $\Delta \Sigma$  Conversion

### Sampling Frequency

48 kHz

### Memory

Non-volatile

### Frequency Response

10 Hz to 22 kHz (+0/-3 dB)

### Nominal Input Level

-40/-20/0 dBm (Balanced)

### Input Impedance

20 k $\Omega$  (-20/0 dBm), 3 k $\Omega$  (-40dBm)

### Maximum Input Level

+24 dBm (Limiter: On, 0 dBm, Balanced)

+20 dBm (Limiter: Off, 0 dBm, Balanced)

### Head Room

20 dB (-40/-20 dBm), 18 dB (0 dBm)

### Nominal Output Level

-40/-20/0 dBm (Balanced)

### Output Impedance

600  $\Omega$ : 2 pin(HOT) - 3 pin(COLD)

300  $\Omega$ : 2 pin(HOT) - 1 pin(GND) / 3 pin(COLD) - 1 pin(GND)

### Maximum Output Level

+18 dBm (0 dBm, Balanced into 600  $\Omega$ )

### Total Harmonic Distortion

0.05 % or less

### Dynamic Range

97 dB or greater (-20 dBm)

### Anti-Feedback Characteristic

Center Frequency: 20 Hz to 20 kHz

Q: Max 100

Cut Level: Max -40 dB

Filter Width: Min 1/20 oct

### Functions

Auto Adjust Function (Filter: 12)

Filter Wide Function

Dynamic Adjust Function (Filter: 2)

Diffuse Function

Limiter Function

Enhancer Function

Low-Cut Filter

High-Cut Filter

Phantom Power (+48 V)

Output Phase Function

Output Ground Lift Function

### Connectors

INPUT: XLR-3-31 Type / 1/4 inch TRS Phone Type for common use

OUTPUT: XLR-3-32 Type, 1/4 inch TRS Phone Type

\* XLR Type: 1: GND, 2: HOT, 3: COLD

1/4 inch TRS Phone Type:

Tip: HOT, Ring: COLD, Sleeve: GND

### Power Supply

AC 14 V (BOSS BRC-Series)

### Current Draw

500 mA

### Dimensions

138 (W) x 197 (D) x 43 (H) mm

5-7/16 (W) x 7-13/16 (D) x 1-3/4 (H) inches

### Weight

600 g (excluding the AC Adaptor) / 1 lb 6 oz

### Accessories

Owner's Manual, AC Adaptor BOSS BRC-Series,

Roland Service

### Option

Rack Mount Adaptor RAF-70

\* 0 dBm = 0.775 Vrms

\* *In the interest of product improvement, the specifications and/or appearance of this unit are subject to change without prior notice.*

### About the AF (Adaptive Focus) Method

This newly developed AD conversion process virtually eliminates all quantization noise, and dramatically improves overall dynamic range. It accomplishes this by using two types of AD converters (with different input levels) to convert audio signals into data in combination with a unique DSP method for creating a composite of the separately obtained data streams.

For the U.K.

**IMPORTANT:** THE WIRES IN THIS MAINS LEAD ARE COLOURED IN ACCORDANCE WITH THE FOLLOWING CODE.

BLUE: NEUTRAL  
BROWN: LIVE

As the colours of the wires in the mains lead of this apparatus may not correspond with the coloured markings identifying the terminals in your plug, proceed as follows:

The wire which is coloured BLUE must be connected to the terminal which is marked with the letter N or coloured BLACK.  
The wire which is coloured BROWN must be connected to the terminal which is marked with the letter L or coloured RED.  
Under no circumstances must either of the above wires be connected to the earth terminal of a three pin plug.



For Europe

This product complies with the requirements of European Directive 89/336/EEC.

For the USA

### FEDERAL COMMUNICATIONS COMMISSION RADIO FREQUENCY INTERFERENCE STATEMENT

This equipment has been tested and found to comply with the limits for a Class B digital device, pursuant to Part 15 of the FCC Rules. These limits are designed to provide reasonable protection against harmful interference in a residential installation. This equipment generates, uses, and can radiate radio frequency energy and, if not installed and used in accordance with the instructions, may cause harmful interference to radio communications. However, there is no guarantee that interference will not occur in a particular installation. If this equipment does cause harmful interference to radio or television reception, which can be determined by turning the equipment off and on, the user is encouraged to try to correct the interference by one or more of the following measures:

- Reorient or relocate the receiving antenna.
- Increase the separation between the equipment and receiver.
- Connect the equipment into an outlet on a circuit different from that to which the receiver is connected.
- Consult the dealer or an experienced radio/TV technician for help.

Unauthorized changes or modification to this system can void the users authority to operate this equipment.  
This equipment requires shielded interface cables in order to meet FCC class B Limit.

For Canada

#### CLASS B NOTICE

This digital apparatus does not exceed the Class B limits for radio noise emissions set out in the Radio Interference Regulations of the Canadian Department of Communications.

#### CLASSE B AVIS

Cet appareil numérique ne dépasse pas les limites de la classe B au niveau des émissions de bruits radioélectriques fixés dans le Règlement des signaux parasites par le ministère canadien des Communications.

For Australia

The supply cord of this transformer cannot be replaced; if the cord is damaged, the transformer should be discarded.

 Roland®

70904256

UPC 70904256



18901



AF-70

Roland Corporation

01230156 '97-I-B3-11D